

nt

Folding Table  
NT Series



okamura



**Flexibility**  
for creative workspaces

**For any spaces,  
for any occasions...**

NT delivers the flexibility you need  
to use your spaces effectively.



Training sessions



Brainstorming

**Straight nesting**

Straight nesting for efficient storage;  
large casters for smooth and easy movement.

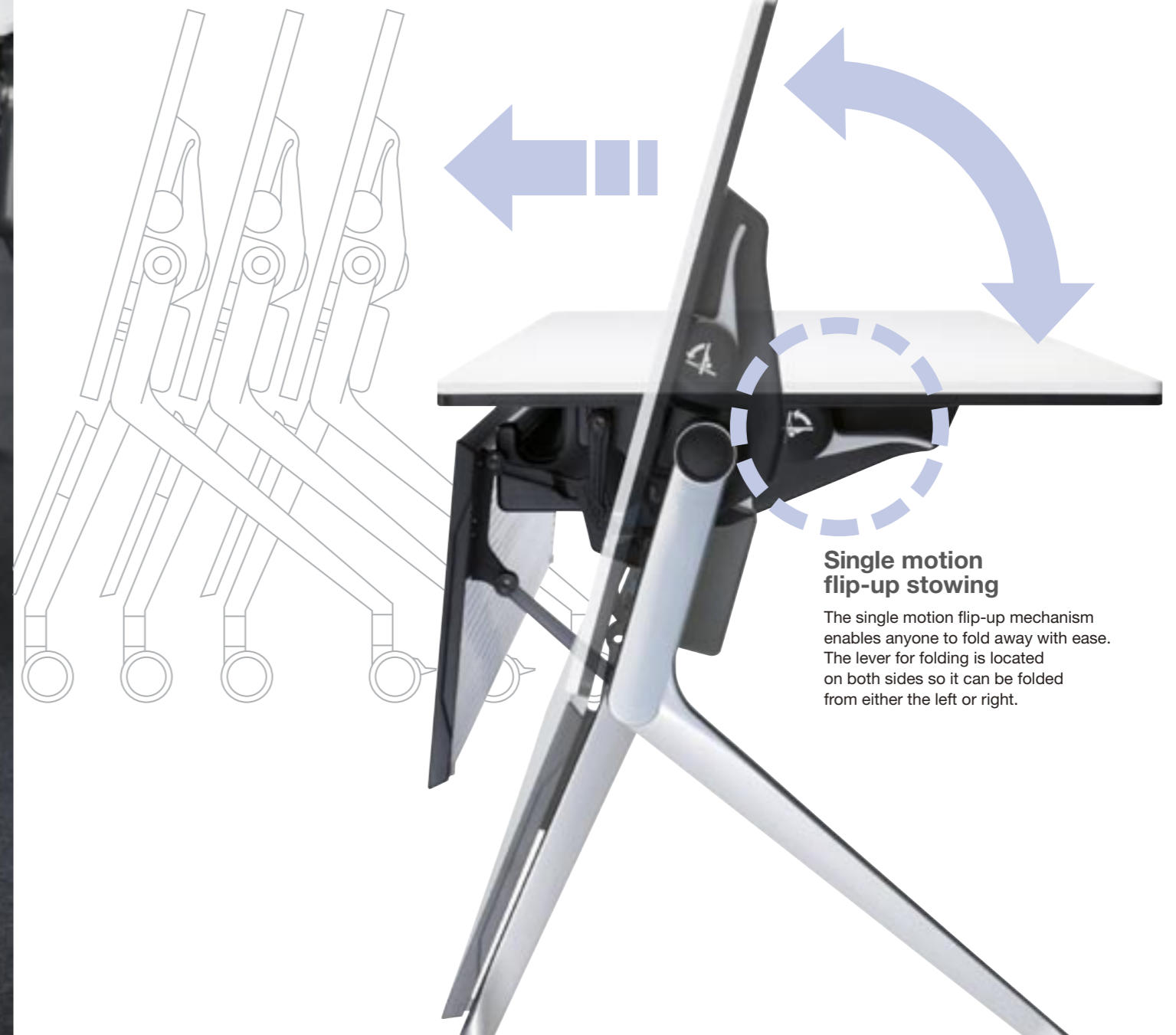

**Single motion  
flip-up stowing**

The single motion flip-up mechanism  
enables anyone to fold away with ease.  
The lever for folding is located  
on both sides so it can be folded  
from either the left or right.



Full view



Level adjustable:  
Casters are individually level adjustable within 0–10mm to allow for uneven floors.

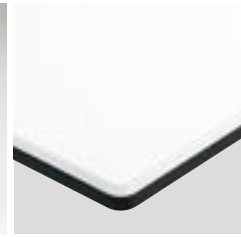

Tabletop color: White  
MH47

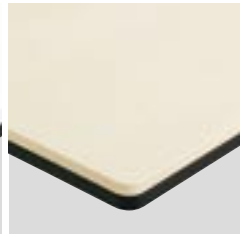

Tabletop color: Light Plain  
MH46

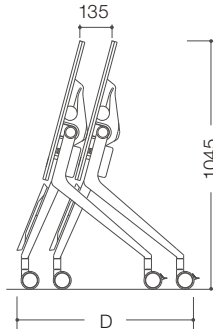
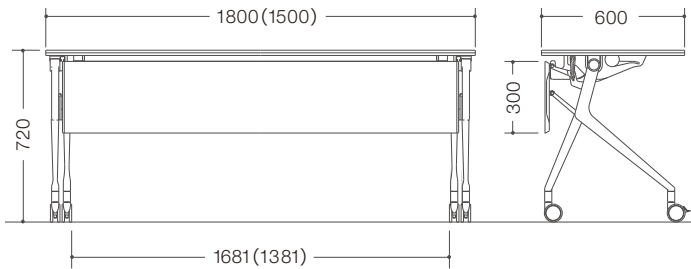

Space required for nested storage:

1800W / 1500W

D:  $480 + (\text{number of tables} - 1) \times 135\text{mm}$  (450D)

D:  $630 + (\text{number of tables} - 1) \times 135\text{mm}$  (600D)

#### Size variations

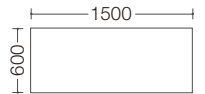
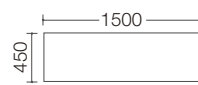
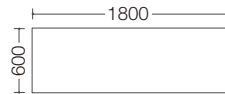
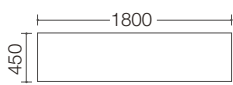

#### Options:

Modesty panel, Document shelf

#### Materials:

Tabletop: laminated melamine  
Edge finish: ABS  
Legs: die cast aluminum  
Modesty panel: ABS

#### Environmental aspects:

54% recyclable  
Contains 58% recycled materials  
Designed for disassembly  
Major components are labeled for ease of recycling  
All company activities managed by ISO 14001 system

#### Specifications:

Single motion flip-up mechanism  
Nestable for straight storage and stowing  
Wiring features  
Level adjustable (max. 10mm)  
75mm dia. casters for easy moving  
22mm thickness tabletop with two-tone edge  
Max. bearing weight: 60kg (uniformly distributed)

#### Standards:

EN527-1/2/3

**okamura**

**OKAMURA CORPORATION**

International Sales & Marketing Div.

Kokusai Shin-Akasaka Bldg. W., 10th fl.,

6-1-20 Akasaka, Minato-ku, Tokyo 107-0052, JAPAN

Tel: +81-3-5561-4085 Fax: +81-3-5561-4086

<http://www.okamura.co.jp/>

The products listed in this catalog are available as of October 2006. Please note that specifications, dimensions, and colors are subject to change without notice. The colors of the actual products may differ somewhat from the colors shown in the catalog, depending on printing conditions. The dimensions given in this catalog are in millimeters.